



# Original Instruction manual

## ICE WATER COOLING

**EWK**  
for  
white and green asparagus and cherries

Manufacturer:  
HMF Hermeler Maschinenbau GmbH  
Lohmannstr.4  
D-48336 Sassenberg-Füchtorf  
Phone: 0049 (0) 54 26 / 53 84  
Fax: 0049 (0) 54 26 / 53 85  
e-mail: [verkauf@hmf-hermeler.de](mailto:verkauf@hmf-hermeler.de)  
Website: [www.hmf-hermeler.de](http://www.hmf-hermeler.de)

## Table of content

	page
1. Introduction	3
2. Content	3
3. General notes	3
3.1 Particularly note	3
3.2 Description of the type plate	4
4. Safety instructions	5
4.1 Safety and accident regulations	8
5. Application possibilities	8
6. Before commissioning	9
7. Commissioning	9
8. Description	9
9. Operating the system	10
9.1 Shocking white asparagus	11
9.2 Storage of white asparagus	14
9.3 Shocking cherries / green asparagus	15
9.3.1 Idle running when shocking cherries / green asparagus	16
10. Chiller	16
10.1 Chiller commissioning	17
10.2 Frost protection for the chiller	17
11. Roller shutter	17
11.1 Instructions for setting up the roller shutter	18
12. Checking the direction of the pump rotation	24
13. Maintenance & Care	24
14. Notes on recommissioning	24
15. Cleaning schedule	25
16. Information on DIN VDE	26
16.1 Additional notes	27

# 1. Introduction

This instruction manual is valid for the the ice water cooling EWK. It is made for the persons who work with this machine and it gives you advices for the use, the adjusting and the operation of the ice water cooling EWK. Texts and pictures are neutral as far as possible. To differences it is drawn the attention by picture headings or text tips.

Manufacturer:  
HMF Hermeler Maschinenbau GmbH  
Lohmannstr. 4  
D - 48336 Sassenberg-Füchtorf  
Phone: 0049 (0) 5426 5384  
Fax. 0049 (0) 5426 5385  
Mail: [verkauf@hmf-hermeler.de](mailto:verkauf@hmf-hermeler.de)

## 2. Content

Read this instruction manual carefully and completely before working with the machine. Follow the advice for the proper care and maintenance of your machine and you will achieve constant readiness for operation and a long service life for your machine.

## 3. General notes

### 3.1 Particular note

The information in this instruction manual must be read, understood and observed by all persons who use, operate, maintain or check these machines in order to prevent hazards. In particular, read the section "Safety instructions".

The use of spare parts, accessories and additional equipment that do not originate from HMF and have not been tested and approved by HMF, that adversely change the design properties of the HMF device or its functionality and thereby impair the active and/or passive mode of operation and occupational safety (accident prevention) is not permitted.

HMF accepts no liability whatsoever for damage caused by the use of non-HMF original parts, accessories and ancillary equipment. Technical specifications, dimensions and weights are not binding. We reserve the right to make changes in the course of technical development and errors

## 3.2 Description of the type plate

The serial number of the machine, the type and the year of manufacture are stamped into the type plate. The machine number, type designation and year of manufacture can be found on the type plate on the control cabinet..

In the case of a spare parts order, please provide us with the following information:

**1. Type**

**2. Year of manufacture** →

**3. Serial number** →

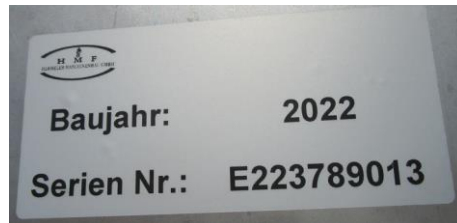

## 4. Safety instructions

This sign on the machine or in the instruction manual draws your attention to the security advices. If you don't pay attention to it, there is danger for your life and serious injuries.

Please observe all rules and instructions and give them to all other users, too!

### Marking of warnings and hazards

In these instruction manual we have marked all passages concerning your safety and the safety of the machine with the following symbols. Pass on all safety instructions to other users as well !



#### **Danger!**

Marking of instructions which, if not followed, pose a risk to the life and limb of the operator or other persons + measures to avoid the danger



#### **Attention!**

Marking of instructions which, if not followed, may result in damage to the machine + measures to avoid danger to the machine

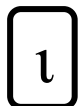

#### **Attention!**

Marking of indications that enable a more effective and economical use of the machine



#### **Environment!**



Marking of indications that pose a risk to the environment if not observed

There is an environmental hazard if environmentally hazardous substances (e.g. oils, foils, etc.) are not handled properly and/or disposed of.

The warning and information signs attached to the machine provide important information for safe operation. Observance of this information is for your own safety.

In general:

- a) Strictly follow warning signs and information signs!
- b) Give all security instructions also to all other users of this product!
- c) Please keep all signs and warning signs in good condition or replace them if necessary!

	<p>Please read instruction manual and security advices before starting on!</p> <p>In case of all maintenance and working of repairs stop the motor and remove the ignition key!</p>
	<p>Don't stay in the working area while using the lifter!</p> <p>While using the machine it is not allowed to stay between the tractor and the machine!</p>
	<p>Don't touch machine parts until they don't move any longer!</p> <p>Don't open protection appliances while using the machine or while the engine is running!</p> <p><b>NEVER touch revolving parts!!!</b></p> <p>Don't stay near the revolving rotors and never touch moving machine parts! Wait until they don't move any longer!</p>



**There is danger of contusion!**



**Caution!  
There is danger of hurled-out pieces while machine is running!**

**Pay attention to keep a safe distance to the machine!**



**Don't stay in the swerving area of the machines!**

## 4.1. Safety and accident regulations

- In addition to the information in this instruction manual, observe the general safety and accident prevention regulations.
- Before starting work, familiarise yourself with all control units and their functions. It is too late to do this during work!
- Before starting, ensure that all guards are in place and in the protective position.
- The worker's clothing should be tight-fitting. Avoid loosely worn clothing!
- When repairing the machine, the power supply must be disconnected! The CEE plug must be pulled out.
- The EWK may only be entered when the machine has been disconnected from the power supply.
- The roller shutter has no emergency stop! When the roller shutter is in operation, no one may be in the movement area of the roller shutter.
- Never touch the control cabinet with sweaty or wet hands!
- The control cabinet may only be opened when the machine's electrical main switch is in the "off" or "0" position.
- All pumps and components must be installed in a frost-proof location!
- Repairs to the machine may only be carried out by qualified personnel.
- Other users must be instructed in the machine.

In addition to the above-mentioned instructions for accident prevention, the generally recognised safety, occupational health and road traffic regulations apply, cf. the regulations of the agricultural trade associations..

## 5. Application possibilities

The EWK cabinet is suitable for shocking and storing pre-cleaned white asparagus or only for shocking pre-cleaned green asparagus or pre-cleaned cherries. The operating mode differs for both applications.

Switching between the two operating modes takes place in the control cabinet

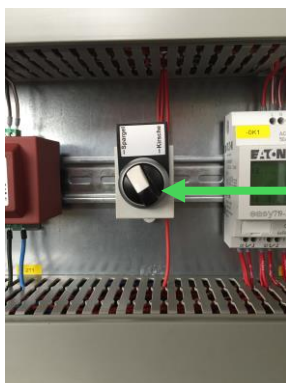

Switching between „cherries/green asparagus“ or „white asparagus“



## 6. Before commissioning

To take full advantage of your new machine, please read and follow this instruction manual before using your machine. Before using the machine, check that it has been delivered complete. Remove the packaging carefully and completely. Familiarise yourself with the technical instruments. Please always observe the safety instructions. We must reject warranty claims resulting from improper handling!

## 7. Commissioning

- The EWK must first be transported to its final location. It should be placed on as level a surface as possible.
- A 3" or 2" socket valve is fitted for the water drain. Please ensure that the used water drains properly.
- Depending on the version, the power connection requires: 400V/16A or 32 A or 230V plug connection. It must be ensured that all power supply cables and sockets have 5 cores and are connected correctly.
- The shock cabinet must be connected to the separately installed chiller using a hose/pipe.
- Use a hose to fill the basin under the gratings with fresh water up to the lower edge of the gratings. To do this, 1 - 2 gratings must be temporarily removed. The stainless steel pipes must be completely submerged in water.
- You should then ensure that the switches for the pump (3), the cooling system (2) and the roller shutters are set to "OFF".
- The entire system must stand still for 2 - 3 hours to allow the coolant to settle. It is best to keep the roller shutters closed during this time. To do this, set the main switch (1) to "ON" and only then operate the switch for the roller shutters. Then set all switches back to "OFF".

**Submersible pumps must not run without water, otherwise the seals in the submersible pump will be destroyed.**

## 8. Description

The EWK cabinet consists of an insulated stainless steel basin. A submersible pump delivers cold water to a perforated plate for sprinkling the asparagus. With the help of the chiller, ice builds up on the stainless steel pipes to cool the water. The pump, the roller shutter and the cold water substitute can be switched via a control cabinet.



Different running times for the pump can be selected via a switch in the control cabinet. When "shocking", the pump runs continuously for a certain time to cool the white asparagus (e.g. 20 min). When storing, the pump switches on intermittently for a short, previously selected time (at least 2 min) to keep the asparagus cool and moist. When used for **asparagus**, the water is cooled down to 0°C. An ice coating forms on the stainless steel pipes in the shock cabinet. The operation of the chiller is controlled by an ice build-up sensor. The appliance is started when the ice thickness reaches a minimum value. The chiller is switched off again when the ice build-up reaches a set maximum value.

In the **cherries / green asparagus** application, the water is cooled to a pre-set temperature range, e.g. 2°C to 4°C. The temperature is above the freezing point of the water. An ice coating forms on the stainless steel pipes and the chiller is controlled via an ice build-up sensor. The cold water runs through the stainless steel pipes and can be kept within a certain temperature range using a temperature sensor. A submersible pump delivers the cold water to a perforated plate for sprinkling the cherries/green asparagus.

## 9. Operating the system

To supply power to the cabinet, the main switch (1) must be set to "On". The chiller has its own main switch on the unit itself.

**Always keep the roller shutters closed, otherwise the pumps will not run.  
Also, the pumps must never be switched off.  
If the pumps are not running, there is a risk of icing up!**

## 9.1 Shocking white asparagus

With the digital timer (see photo), the operating time of the pump during shocking can be set. To shock the asparagus, a certain running time (e.g. 20 min) for the pump is selected with the digital timer. The pump then runs for this time and shocks the asparagus in the refrigerator down to 1° - 2° C. After the selected time has elapsed, the EWK automatically switches back to the "store" programme. A running time between 0 and 9.99 hours can be selected on the digital timer.

We recommend a running time of the pumps of approx. 20 - 30 min for shocking one layer of asparagus boxes. If several boxes are stacked on top of each other, the running time for the pumps must be increased accordingly.

After the preset shock time has elapsed, the previously selected storage mode is automatically set again.

### Pump control

The pump switch must be on for the respective field and the roller shutter for the field must be down.

If the switch is "ON" (8) (13) and the roller shutter (9) (12) is down, the pumps are either started by the timer or automatically by the interval timer (3 min ON, 15 min OFF alternately).

If there is too little water, the pumps are automatically switched off to prevent dry running.

The lack of water is signalled by a light on the control cabinet "low water" (3) and the warning light "yellow" (2).

In order to be able to restart the pumps, water must first be filled up and a RESET by switching the pump switches off and on again.

### Cooling control

The switches « cooling field 1 » (5) or « cooling field 2 » (7) activate the cooling. A request is sent to the chiller and the corresponding valve for the field opens.

As long as there is a request, the "cooling request" light (4) on the control cabinet lights up and the water is cooled down at that moment.

The current water temperatures can be read off the temperature displays (6) (14).

When the water has reached its set temperature, the cooling request (4) is switched off, but the last valve remains open for another 3 min.

### Automatic water filling

Automatic filling is activated as standard and can be deactivated in the PLC. The precondition is that the roller shutters are closed.

After 30 seconds of standstill of the pumps, the solenoid valves open and the water level is filled.

If the process is interrupted by starting the pumps, it continues automatically when the pumps stop until the target level is reached.

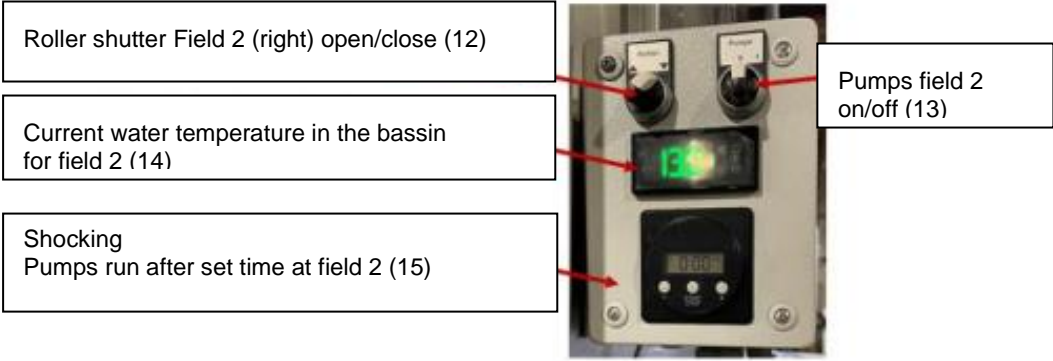
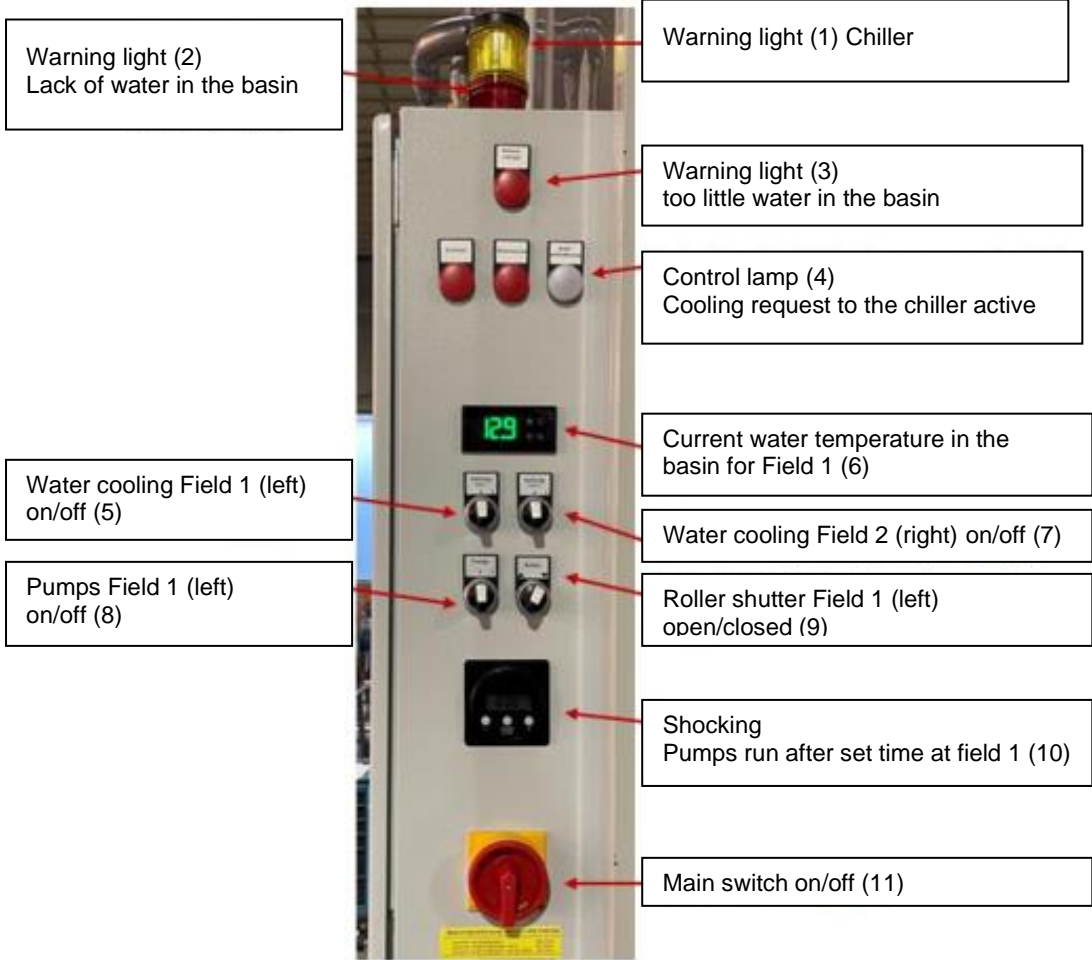

## Digital time switch in detail

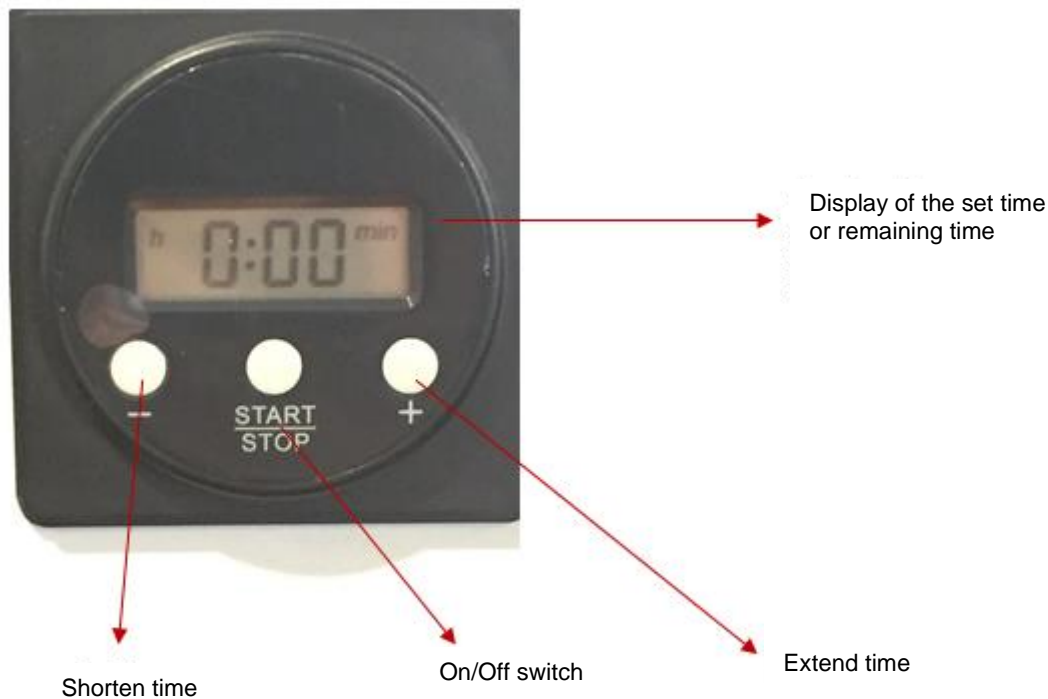

### Description of the operating elements

The +/- switches extend or shorten the setting times of the pump. The "Start/Stop" button serves as an on/off switch. The setting range is up to 9:59 hrs/min.

To start the pumps, the following procedure must be followed:

1. Switch on the pump with the switch (3).
2. Use the +/- keys to set the running time of the pump.
3. Press the "Start/Stop" button to start the pump (shock).
4. The clock runs backwards to "0". The remaining running time remains visible.
5. After the set time has elapsed, the clock jumps to the preset time.
6. The running time of the pump can be adjusted after the time has elapsed by using the +/- keys.
7. To start the pump again, press the "Start/Stop" button.

## 9.2 Storage of white asparagus

---

The "Storage" programme is always activated automatically as soon as the cabinet is switched on.

With this programme the pump is switched on automatically for a short time at pre-selected intervals to keep the asparagus in the cabinet cool. The pauses can be set on the time relay from 12 - 60 min. **(The pause interval must not be less than 2 min, otherwise the pump will be damaged)**. A pause duration of 20 min and a pump running time of 2 min.

These settings are made in the in the control cabinet. Please observe the instructions on the inside of the control cabinet door and the picture below.

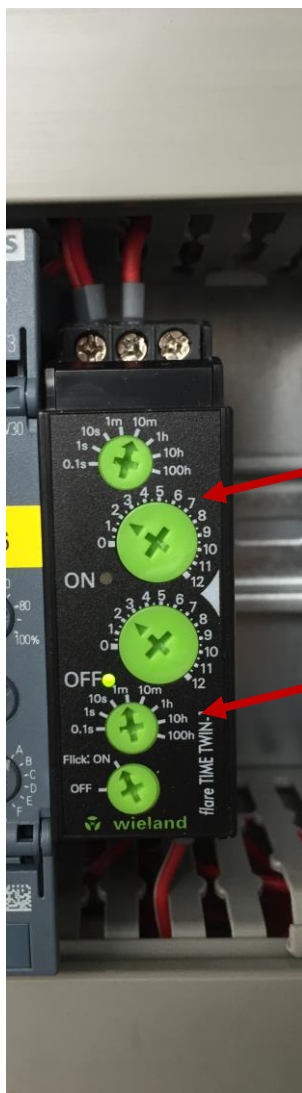

**Break time pump:**  
The break time is set via the two upper controllers.  
The values of the two controllers are to be multiplied.  
Example : 10 min x 2 = 20 min break

**Running time pump:**  
The running time of the pump is set via the two lower controllers. The values of the two controllers are to be multiplied.  
Example: 2 min x 1 = 2 min running time pump

The shock and storage times can be individually adjusted at any time.

## 9.3 Shocking cherries / green asparagus

The temperature of the water for shocking the cherries / green asparagus can be set on the water temperature display (6 + 14):

There is a signal light on the control cabinet. As soon as the preset time for shocking has elapsed, the light flashes. The signal light indicates that the roller shutter can now be opened and the cherries/green asparagus removed.



1. Not operable
2. Not operable
3. SET button
4. UP button
5. DOWN button
6. ON/OFF button

The water in the shock cabinet is kept within a certain temperature range. The temperature of the water is measured via a temperature sensor. If the water temperature exceeds a previously set value, the chiller is started. The water is now cooled down. As soon as the water temperature reaches a lower limit value, the chiller switches off again.

Example:

- Start water chiller at 4°C water temperature
- Switch off chiller at 2°C water temperature

### **Setting the upper value for the water temperature:**

The current water temperature is always shown in the display. By pressing the SET button (3), the set temperature for the upper limit of the water appears in the display. If button 3 (SET button) is held down for longer, the display starts to flash. The set value can now be changed using the arrow buttons (4) and (5). Press the SET button (3) again to save the entry.

### **Setting the lower value for the water temperature:**

The lower value for the water temperature is not entered directly. Instead, a cooling temperature is entered, i.e. the amount by which the water temperature should be cooled, e.g. -2°C.

The cooling is entered via the Hy parameter. Pressing the SET button (3) and DOWN button (5) simultaneously takes you to the programming level. The buttons must be held down for a few seconds. The "°C" LED light flashes. The individual setting parameters now appear in the display. As soon as "Hy" appears on the display, press the SET button (3) alone once. The default value for the Hy parameter is now displayed, e.g. -2°C. The default value can be changed using the "UP/DOWN" button (4) and (5). The display value is saved by pressing the SET button (3).

Press the SET button (3) and the Up button (4) simultaneously to exit the programming level.

### 9.3.1 Idle running when shocking cherries / green asparagus

If there are no cherries/green asparagus in the cabinet and the water is to be kept at temperature, the following conditions must be met:

The roller shutter switch must be set to down -> "Closed" so that the pumps can run and the water can circulate.

There is a time relay in the control cabinet. This ensures that the pump is in cooling mode, i.e. the pump is switched in interval mode:

2 min pause - 2 min pump runtime

This is necessary because the temperature sensor is located upstream of the pump. The cold water reaches the sensor through the circulation. Otherwise the display can deviate greatly from the value in the water.

The programme is always activated automatically as soon as the cabinet is switched on (can be changed individually).

## 10. Chiller

The chiller is controlled by a temperature sensor. If the ice coat on the stainless steel pipes falls below a certain coat thickness set via the temperature sensor, the chiller starts up and fills the ice coat again. The temperature sensor should be set so that the ice coat of the stainless steel pipes have a diameter of 40-50 mm. **Under no circumstances should a closed block of ice be formed.** The chiller only runs when the stainless steel pipes in the tank are covered with water.



To defrost the unit, set the "Cooling" switch (2) and the main switch directly on the chiller to "0" or "OFF". Continue to operate the unit until the ice on the stainless steel pipes has melted.  
Never try to "pick off" the ice, as this may cause damage to the stainless steel pipes.

## 10.1 Commissioning chiller

See separate instruction manual for the chiller.

## 10.2 Frost protection for the chiller

### Please note:

At temperatures below zero, it must be ensured that the antifreeze added to the water-glycol mixture withstands the minus temperatures. This should be checked with a measuring device, especially in the winter months.

## 11. Roller shutter

The roller shutter is operated via the switch on the control cabinet or on the side of the EWK. The roller shutter is raised to load the EWK. The pump is switched off, even during the conveying process. Switching off the pump prevents the water from spraying out of the open area. After charging, the roller shutter is lowered. The pump is in operation again and the shock or storage operation continues. The shutter should be down so that the functions of the storage or shock interval can be guaranteed or continued.



Roller shutter switch

## 11.1 Instructions for setting up the roller shutter

1. Two persons should stand on the EWK. A third person lifts the roller shutter with a forklift onto the EWK where it is accepted and aligned by the two persons standing on top.



2. Now the roller shutter slats must be inserted into the lateral guide rails of the EWK. To do this, carefully tilt the roller shutter box by approx. 80° and insert the roller shutter slats into the guide rails.



3. The side brackets must be inserted into the holders. Then the roller shutter box lies securely fixed on the EWK.



4. Then you have to
  - a. connect the plugs together,



b. cover of the connector screws,



c. and then plug the finished, screwed, complete connector onto the bracket.



# Rolladen Standard / H 55 E

- Kastensystem GKSE

RT 01

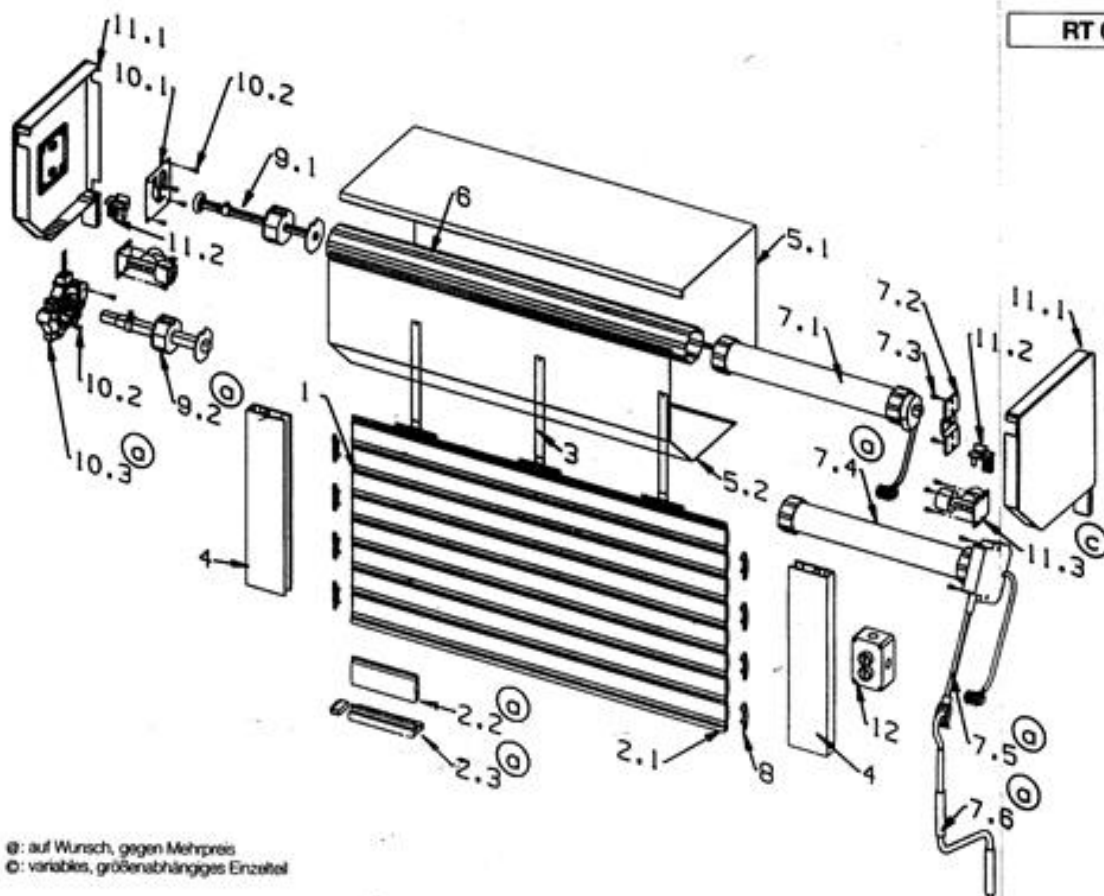

⊕: auf Wunsch, gegen Mehrpreis  
⊙: variables, größenabhängiges Einzelteil

## Stückliste RT 01

1	Rolladenpanz. Stand., H 55 E
2.1	Kunststoff-Endleiste
2.2 ⊕	Alu-Endleiste m. Gummi
2.3 ⊕	Verstärkungsprofil m. Abd.
3	Stahlbandaufhängungen
4	Führung H-STF
5.1	GKSE-Blende, obere
5.2	GKSE-Blende, untere
6	Stahlwelle 75-8 k
7.1	Rohrmotor
7.2	Motorlager
7.3	Schrauben f. Motorl.
7.4 ⊕	Rohrmotor NHK
7.5 ⊕	Öse m. 4-k. Verläng.
7.6 ⊕	Handkurbel
8	Arretierstücke
9.1	Wellenbolzen 75-8 k
9.2 ⊕	Wellenbolzen 75-8 k (Abrolls.)
10.1	Lagerplatte GKSE
10.2	Befestigungsschrauben
10.3 ⊕	Abrollssicherung
11.1	GKSE-Blendekappe
11.2	PA-Einlaufstützen
11.3 ⊕	Einlaufrollen (nur GKSE 300)
12	Zweitaster

## STANDARD-ROLLADEN m. GKSE Kastensystem m. Rohrmotor, auch NHK

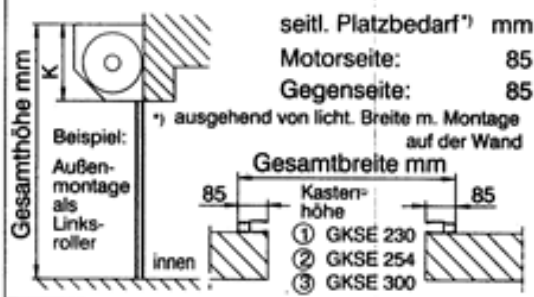

s.Pl. = seitl. Platzbedarf

Panzerhöhe (mm)	Ballendurchmesser	Standard	H 55 E
	∅ mm Welle 75-8 k	∅ mm Welle 75-8 k	∅ mm Welle 75-8 k
1.500	190	192	
1.750	220	199	
2.000	220	220	
2.250	245	222	
2.500	245	240	
2.750	249	240	
3.000	252	240	

# Fine adjustment roller shutter

## Adjusting the end positions

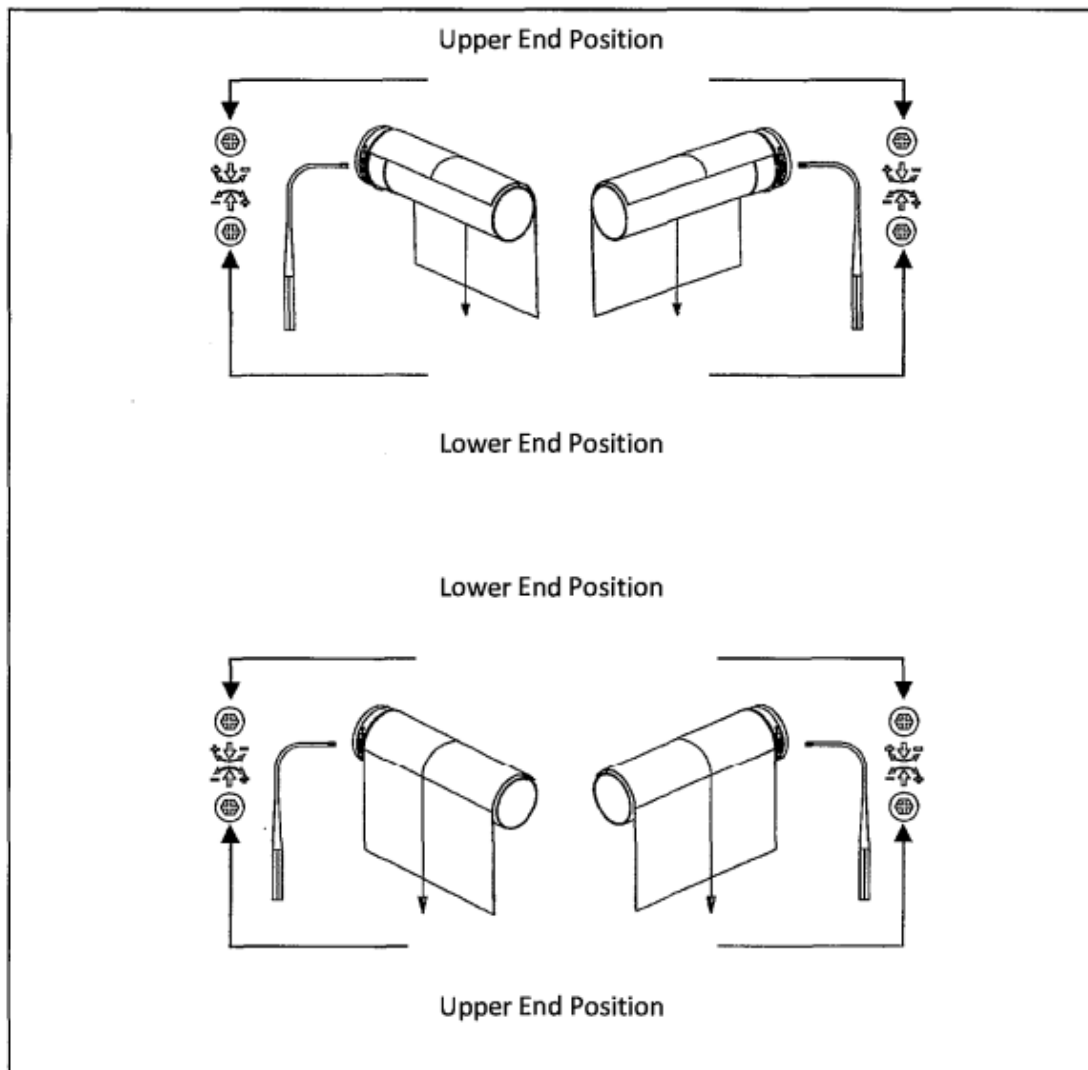

### Adjustment of the Lower End Position

1. Please let the motor drive in direction downwards until it stops automatically, BEFORE you join the roller door to the winding shaft!
2. Please position by fine-tuning of the lower end position of the winding shaft in that way that you can afterwards join the hangings easily to the winding shaft.

### Adjustment of the Upper End Position

Please activate the switch for the upwards-direction. The motor rolls up the hangings. Enlarge or reduce the range by turning the correspondent adjustment-screw.

5. Mounting perforated plate:

- a. The perforated plate must be lifted into the EKW so that the filter is on the same side as the water drain.



- b. The perforated plate is fixed with 4 metal bolts.



- c. The metal bolts are fixed with screws.



## 12. Checking the direction of the pump rotation

- The direction of the pump rotation must be checked before commissioning. Since the pump is supplied with 400 volts, phase shifts may occur.
- There is an arrow on the cast housing of the pump that indicates the direction of the impeller rotation. Furthermore, an incorrect direction of the pump rotation is noticeable by strong noise development.
- To check the direction of rotation, it may be necessary to run the pump outside the water basin. When doing this, the pump may only be switched on briefly, as "dry" operation can damage the pump.
- If the pump runs upside down, two phases of the power supply for the pump must be changed in the switch cabinet or in the plug. This changes the direction of rotation.

## 13. Maintenance & Care

On the perforated plate for sprinkling the asparagus there is a sieve to clean the water from fibrous material. This sieve must be cleaned daily or more often depending on the degree of contamination. The perforated plate should also be cleaned daily. To do this, loosen the fastening bolts on the side and let the perforated plate fold down. (Attention: heavy!) Then the cleaning can be done. Then fold the perforated plate back up and carefully fasten it again!

The water itself should also be changed as required (approx. every 2 - 3 days). Defrosting the unit is not absolutely necessary for this. The dirt should be rinsed out of the ice water basin with a water hose.

## 14. Notes on recommissioning

- Has condensation formed in the control cabinet due to moisture from the air during the winter? If so, please dry / ventilate and only connect to the power supply after everything has dried. (Danger!)
- Is the direction of the power rotation supply correct? (clockwise)
- Are 5 cores connected in all sockets / supply lines (also extension cables)? This is mandatory, otherwise control modules can be damaged.
- Check all plugs and cables for damage.
- Check the steel band suspension on the roller shutter doors.
- Check electronic components.
- Glycol still sufficient?
- Please have all screw connections of the refrigeration system checked by a refrigeration specialist before commissioning!



## 15. Cleaning schedule

	daily	weekly	14-daily	before or after season
Change water (no defrosting necessary), rinse with clear water	every 2-3 days			
Clean the sieves and the perforated plate, spray with water and clean from dirt	X			
Check the pump for contamination		X		
Clean the inside of the machine with water (also the roller shutters)		X		
Hose down grates with water		X		
Check fan/chiller/filter, clean if necessary			X	
<p>Clean the whole machine thoroughly</p> <p>Empty the machine, clean the inside:</p> <ul style="list-style-type: none"> <li>- Dissolve sodium hydroxide (caustic soda) in lukewarm water (follow the manufacturer's recommendations for the mixing ratio!), add to the water tank of the EWK.</li> <li>- Allow to run for approx. 2 hours until the dirt film is gone. Then drain off the liquid.</li> <li>- Rinse thoroughly with clean water: To do this, let in new water at least twice, let it run through for 15 minutes each time, then drain.</li> </ul> <p>Afterwards, you can rinse again with citric acid. (To do this, mix water with citric acid (follow the manufacturer's recommendations for the mixing ratio!), fill the water tank of the EWK, let it run for 15 minutes, drain and rinse.</p>				X

## 16. Information on DIN VDE

Citation:

DIN VDE 0100 part 705

### 3 Protection against shock current

3.2 Electric circuits with sockets of the TN-, TT-, IT-system have to be protected by residual current devices with a nominal fault current  $I_{\Delta n}$  shorter or equal 30mA.

3.3 For preventive measures at indirect touching by automatically disconnection of the electrical power supply there is valid as stipulated limit of the permanent allowed touching-voltage  $U_L=25V$  AC voltage RMS-value or 60V DC voltage (harmonic-free) for zones of cattle breeding. The maximum disconnecting-time until the cut-off of the electrical power supply will be shown in a chart which is in preparing now.

### 4 Protection against thermic influence

4.1 Fire protection

The fire protection has to be assured by a residual current device with an  $I_{\Delta n}$  shorter or equal than 0,5A.

### 5 Choice and Installation of electrical utilities

5.3 Control units

Annotation: It is recommended to protect final electric circuits by a residual current device with a nominal fault current as low as possible, preferred up to 30mA, at which no faulty activations appear.

#### Explanations

Concerning 3.2:

If there are devices connected firmly, it is allowed to use a residual current device with an  $I_{\Delta n}$  up to 0,5 A (please see 4.1)

Concerning 3.3:

In agricultural constructions without cattle breeding the allowed touching-voltage is at  $U_L=50V$  AC-voltage RMS-value or 120V DC voltage (harmonic-free) according DIN VDE 0100 part 410.

Concerning 4:

It is not allowed to use residual current devices with a release current higher than  $I_{\Delta n}=0,5A$ .

Concerning 5.3:

This recommendation is addressed to constructions, in which the residual current device does not release while failure-free operation. But because the leakage currents of electrical devices may cause faulty deactivations, it is also allowed to use residual current devices with a higher release current.

In addition the producers of electronic frequency converters recommend the use of all-current sensitive residual current devices.

Additional annotation:

A residual current device with a defined release current must have released at that release current. But this does not determine, that for example an earth leakage circuit breaker (FI) with an  $I_{\Delta n} = 30mA$  does only activate at more than 30mA. Conditional on its construction even a fault current of 20mA may cause an interruption of the earth leakage circuit breaker (FI).

## 16.1 Additional notes

### ADVICE

#### **Advice for roller door using**

Never mount mechanical blocks to consider potential modifications of the length of the roller door. Protect the single lamellas against lateral sliding.

At the bringing into service and at all later use please mind a smooth-running and failure-free motion of the roller door in upwards and downwards direction

#### **Functional check**

For a final check before use please let the hangings move in both directions until the end position.

 **ATTENTION:** The winding motors are made for short-time-use (S2/KB 4 mm). An assembled thermal circuit breaker avoids an overheating of the winding motor. While bringing into service (long hangings resp. long working time) the thermal circuit breaker may be activated. The motor will be stopped then. After a short time of cooling down the motor will work again. The whole working duration will only be reached after the motor has been cooled down to ambient temperature. Please avoid repeated activation of the thermal circuit breaker.

#### **Advices for the electrician**

It is not allowed to parallel the operation of the winding motors with mechanical end deactivation. Please use for the simultaneous activation of several motors the appropriate control systems of the producer of the motors.

Please use for the activation of the Up- and Down-direction the external conductor L1. Other devices or consumer loads (lamps, relays, etc.) shall not be connected directly to the connector leads of the winding motors.

For this the motors and the other devices have to be decoupled by relay controls.

At the installation of the power drive there has to be provided an all-pole disconnecter off the electrical network with at least 3 mm contact-opening-width per pole (EN 60335).

 **ATTENTION** Please use only mechanical or electrical blocked control elements with a distinctive neutral position! This is also valid if there are power drives with electronic end point deactivation and power drives with mechanical end point deactivation used in one construction. The changeover time at changing the direction of move has to be at least 0,5 seconds. Switch and control element shall not work simultaneously on the instruction UPWARDS and DOWNWARDS. Please protect the electrical connections against moisture. Please ALWAYS check by the control elements after finishing the electrical works the correct allocation of the moving direction to the switches UPWARDS- and DOWNWARDS. If the power drive should be driven by tools which content disturbing sources, the electrician has to assemble an adequate disturbance suppression of the affected tools.

#### **Waste disposal**

This product is made of several materials, which have to be disposed appropriately.

Please read up on the valid regulations of recycling or disposal systems for this product in your country.

The packaging material has to be disposed appropriately, too.

#### **Maintenance**

These power drives are maintenance-free.

Technical data 035					
TYPE	P3/30C M	P5/20C M	P5/30C M	P9/16C M	P13/90C M
Nominal torque (Nm)	1	3	5	9	13
Power drive rpm (min <sup>-1</sup> )	30	20	30	16	9
End switch range	38 turns				
Input supply voltage	230 V AC / 50 Hz				
Connection power (W)	85	115	115	110	115
Nominal current consumption rate (A)	0,36	0,47	0,47	0,47	0,47
Control mode	S24 Min.				
Relay technology category	IP 44				
Cl. tube channel-0 (mm)	37				